

APPLICABLE OSHA REGULATIONS DESIGNED TO:

1910.29(b)(1) The top edge height of top rails, or equivalent guardrail system members, are 42 inches (107 cm), plus or minus 3 inches (8 cm), above the walking working surface. The top edge height may exceed 45 inches (114 cm), provided the guardrail system meets all other criteria of paragraph (b) of this section.

1910.29(b)(2)(i) Midrails are installed at a height midway between the top edge of the guardrail system and the walking working surface;

1910.29(b)(3) Guardrail systems are capable of withstanding, without failure, a force of at least 200 pounds (890 N) applied in a downward or outward direction within 2 inches (5 cm) of the top edge, at any point along the top rail.

1910.29(b)(4) When the 200-pound (890-N) test load is applied in a downward direction, the top rail of the guardrail system must not deflect to a height of less than 39 inches (99 cm) above the walking-working surface.

1910.29(b)(5) Midrails, screens, mesh, intermediate vertical members, solid panels, and other equivalent intermediate members are capable of withstanding, without failure, a force of at least 150 pounds (667 N) applied in any downward or outward direction at any point along the intermediate member.

1910.29(b)(6) Guardrail systems are smooth-surfaced to protect employees from injury, such as punctures or lacerations, and to prevent catching or snagging of clothing.

1910.29(b)(7) The ends of top rails and midrails do not overhang the terminal posts, except where the overhang does not pose a projection hazard for employees.

1910.29(f)(1)(ii)(B) The height of stair rail systems installed on or after January 17, 2017 is not less than 42 inches (107 cm) from the leading edge of the stair tread to the top surface of the top rail.

1910.29(f)(2) Finger clearance. The minimum clearance between handrails and any other object is 2.25 inches (5.7 cm).

1910.29(f)(3) Surfaces. Handrails and stair rail systems are smooth-surfaced to protect employees from injury, such as punctures or lacerations, and to prevent catching or snagging of clothing.

1910.29(f)(4) Openings in stair rails. No opening in a stair rail system exceeds 19 inches (48 cm) at its least dimension.

1910.29(f)(6) Projection hazards. The ends of handrails and stair rail systems do not present any projection hazards.

1910.29(f)(7) Strength criteria. Handrails and the top rails of stair rail systems are capable of withstanding, without failure, a force of at least 200 pounds (890 N) applied in any downward or outward direction within 2 inches (5 cm) of any point along the top edge of the rail.

1910.29(g)(4) Platforms used with fixed ladders provide a horizontal surface of at least 24 inches by 30 inches (61 cm by 76 cm).

1910.29(k)(1) The employers must ensure toeboards used for falling object protection:

1910.29(k)(1)(i) Are erected along the exposed edge of the overhead walking-working surface for a length that is sufficient to protect employees below.

1910.29(k)(1)(ii) Have a minimum vertical height of 3.5 inches (9 cm) as measured from the top edge of the toeboard to the level of the walking-working surface.

1910.29(k)(1)(iii) Do not have more than a 0.25-inch (0.5-cm) clearance or opening above the walking-working surface.

TERMS AND CONDITIONS

- Without a written acceptance of these conditions by the Buyer, placement of an order for any of the goods covered by this quotation will constitute acceptance of these terms and conditions. The failure to object to provisions contained in a Buyer's order or other forms of communication will not be deemed a waiver of the terms and conditions.
- ErectaStep is not responsible for delays in satisfying this order caused by circumstances which are unavoidable or beyond our control.
- Typographical errors are subject to correction.
- All information supplied to the Buyer by ErectaStep may contain proprietary design information that belongs to and shall remain property of ErectaStep. They may not be copied without the expressed written consent of an officer of ErectaStep. All information must be returned immediately upon demand.
- ErectaStep sale of goods covered by this quotation does not grant the Buyer any license or right of any kind under any patent owned or controlled by ErectaStep or under which the company is licensee.
- 2 Year Limited Warranty – See below
- Returns: Returns must be in sellable condition and authorization in writing from our office and subject to a restocking fee. Unauthorized returns will be refused. The buyer is responsible for any freight charges.
- Liens: ErectaStep provides final lien waivers when payment is received in full.
- The field measurements utilized in formulating the prices for the equipment supplied by the Buyer or their representative. Any failure of the equipment to operate satisfactorily that is caused by incorrect data and/or field measurements being supplied to the Seller by the Buyer's personnel would be at the buyer's expense. This includes any changes in operating procedures, types of vehicle being serviced, or any changes to the physical surroundings which cause conditions to be outside the original field measurements that were taken. All costs associated with those changes would be at the Buyer's expense.

1910.25(b)(3) Stairs have uniform riser heights and tread depths between landings;

1910.25(b)(4) Stairway landings and platforms are at least the width of the stair and at least 30 inches (76 cm) in depth, as measured in the direction of travel;

1910.25(b)(6) Each stair can support at least five times the normal anticipated live load, but never less than a concentrated load of 1,000 pounds (454 kg) applied at any point;

1910.25(c) Standard stairs. In addition to paragraph (b) of this section, the employer must ensure standard stairs:

1910.25(c)(1) Are installed at angles between 30 to 50 degrees from the horizontal;

1910.25(c)(2) Have a maximum riser height of 9.5 inches (24 cm);=

1910.25(c)(3) Have a minimum tread depth of 9.5 inches (24 cm); and

1910.25(c)(4) Have a minimum width of 22 inches (56 cm) between vertical barriers (see Figure D-8 of this section).

1910.25(c)(5) Exception to paragraphs (c)(2) and (3) of this section. The requirements of paragraphs (c)(2) and (3) do not apply to standard stairs installed prior to January 17, 2017. OSHA will deem those stairs in compliance if they meet the dimension requirements specified in Table D-1 of this section or they use a combination that achieves the angle requirements of paragraph (c)(1) of this section.

Table D-1 Stairway Rise and Tread Dimensions

Angle to horizontal [mm]	Rise (in inches) [mm]	Tread run (in inches) [mm]
30 deg. 35' [10668mm].....	6-1/2 [165mm].....	11 [279mm]
32 deg. 08' [2438mm].....	6-3/4 [171mm].....	10-3/4 [273mm]
33 deg. 41' [12497mm].....	7 [178mm].....	10-1/2 [267mm]
35 deg. 16' [4877mm].....	7-1/4 [184mm].....	10-1/4 [260mm]
36 deg. 52' [15850mm].....	7-1/2 [191mm].....	10 [254mm]
38 deg. 29' [8839mm].....	7-3/4 [197mm].....	9-3/4 [248mm]
40 deg. 08' [2438mm].....	8 [203mm].....	9-1/2 [241mm]
41 deg. 44' [13411mm].....	8-1/4 [210mm].....	9-1/4 [235mm]
43 deg. 22' [6706mm].....	8-1/2 [214mm].....	9 [229mm]
45 deg. 00' [0mm].....	8-3/4 [222mm].....	8-3/4 [222mm]
46 deg. 38' [11582mm].....	9 [229mm].....	8-1/2 [214mm]
48 deg. 16' [4877mm].....	9-1/4 [235mm].....	8-1/4 [210mm]
49 deg. 54' [16459mm].....	9-1/2 [241mm].....	8 [203mm]

1910.28(b)(11)(ii) Each flight of stairs having at least 3 treads and at least 4 risers is equipped with stair rail systems and handrails as follows:

Table D-2 Stairway Handrail Requirements

Stair width	Enclosed	One open side	Two open sides	With earth built up on both sides
Less than 44 inches (1.1 m)	At least one handrail	One stair rail system with handrail on open side.	One stair rail system with handrail on open side.	One stair rail system with handrail on open side.
44 inches (1.1 m) to 88 inches (2.2 m)	One handrail on each enclosed side	One Stair rail system with handrail on open side and one handrail on enclosed side.	One Stair rail system with handrail on open side and one handrail on enclosed side.	One Stair rail system with handrail on open side and one handrail on enclosed side.
Greater than 88 inches (2.2 m)	One handrail on each enclosed side and one intermediate handrail located in the middle of the stair	One stair rail system with handrail on open side, one handrail on enclosed side, and one intermediate handrail located in the middle of the stair.	One stair rail system with handrail on open side, one handrail on enclosed side, and one intermediate handrail located in the middle of the stair.	One stair rail system with handrail on open side, one handrail on enclosed side, and one intermediate handrail located in the middle of the stair.
Exterior stairs less than 44 inches (1.1 m)				

- Buyer assumes liability for patent and copyright infringement when goods are made to Buyer's specifications.
- If the Buyer cancels an order prior to its completion; the Buyer agrees to pay to Seller the percentage of the selling price based on the percentage of the completion, plus any costs for the disposal of used material. The Seller would determine the percentage of completion.
- Indemnity: Buyer shall indemnify and hold harmless ErectaStep, its affiliated companies, owners, employees, agents, and successors from and against any and all claims, expenses, liability, and loss arising from claims for injury, death, or damage to, or destruction of property arising from unauthorized repair or modifications to the products provided under this purchase order/quotation, as well as failure to properly maintain said products, improper use of said products, use of said products for anything other than their intended purpose, and/or the equipment not working or functioning properly caused by a change in working parameters that were unknown by ErectaStep.

WARRANTY

ErectaStep prides itself on it's workmanship and quality. We strive for perfection in each and every part that we manufacture. All ErectaStep parts are warrantied for 2 years against defects. Abuse, extraordinary corrosion, improper installation and other things out of control of ErectaStep are not covered under warranty. Warranty is limited to repair or replacement parts shipped ground to destination as determined by ErectaStep. No additional costs incurred due to warranty related parts are covered i.e. labor, loss of use.

INTENDED USE

All ErectaStep parts are pre-engineered with specific purpose for safe access and egress. It is very important to follow configuration guidelines as well as installation instructions provided with order. Design limitations can exist with respect to required supports, adequate footings and prescribed application. Applied loads beyond the stated design loads and use not as advertised are also not covered under the warranty. Any alteration in design or intended use or purpose beyond ErectaStep's recommendations or knowledge voids our warranty and liability against all claims. ErectaStep offers free design assistance to insure a safe, successful outcome to your project.

1910.144(a)(3) Yellow. Yellow shall be the basic color for designating caution and for marking physical hazards such as: Striking against, stumbling, falling, tripping, and "caught in between."

1926.451(f)(16) Platforms shall not deflect more than 1/60 of the span when loaded.

1910.23(b)(1) Ladder rungs, steps, and cleats are parallel, level, and uniformly spaced when the ladder is in position for use;

1910.23(b)(2) Ladder rungs, steps, and cleats are spaced not less than 10 inches (25 cm) and not more than 14 inches (36 cm) apart, as measured between the centerlines of the rungs, cleats, and steps, except that:

1910.23(b)(4) Ladder rungs, steps, and cleats have a minimum clear width of 11.5 inches (29 cm) on portable ladders and 16 inches (41 cm) (measured before installation of ladder safety systems) for fixed ladders

1910.23(d)(1) Fixed ladders are capable of supporting their maximum intended load;

1910.23(d)(2) The minimum perpendicular distance from the centerline of the steps or rungs, or grab bars, or both, to the nearest permanent object in back of the ladder is 7 inches (18 cm)

1910.23(d)(5) For through ladders, the steps or rungs are omitted from the extensions, and the side rails are flared to provide not less than 24 inches (61 cm) and not more than 30 inches (76 cm) of clearance.

1910.23(d)(12) The step-across distance from the centerline of the rungs or steps is:

1910.23(d)(12)(i) For through ladders, not less than 7 inches (18 cm) and not more than 12 inches (30 cm) to the nearest edge of the structure, building, or equipment accessed from the ladders;







Designed for Work. Built for Safety.



MP SERIES
Mobile Work Platform



G SERIES
Self-Leveling Stairs



TR SERIES
Tilt & Roll Platform



C SERIES
Cantilever Work Platform

RollaStep® rolling stairs and mobile work platforms vary based on your application. They're easily customized for added operational efficiency in manufacturing plants or improved workplace safety in aviation maintenance.



Four precision engineered industrial models minimize physical exertion and risk of injury. Workers gain safe access and fall protection plus greater productivity. If your elevated workspace is more complex, let us fabricate custom mobile platforms and stairs. All RollaStep® mobile stairs and platforms are easy to maneuver and sturdy to help you get the job done easier, faster and safer.

call us toll free **1.888.948.0005**

visit us online **RollaStep.com**

YellowGate®

One Gate. Fits All. Stops Falls.

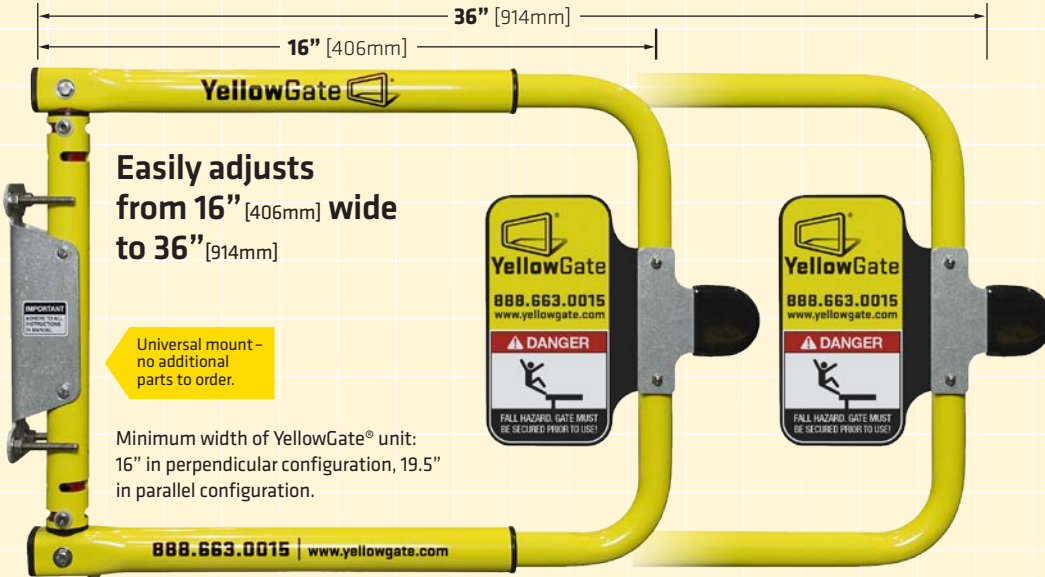

YellowGate® Fall Protection

The Most Adjustable Swing Gate Available

Built to last, outdoors and in.

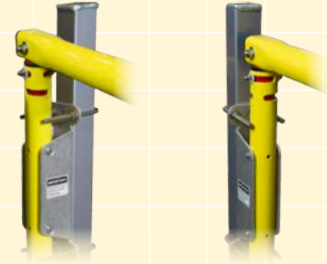

Parallel Mounting Option

Perpendicular Mounting Option

Patent Pending Malbec Tensioner

No spring to fail.

The Malbec Tensioner eliminates the need for a swing gate's most common failure point, the spring. The patent pending system provides field adjustable tension and maintenance free closure, every time.

YellowGate® can swing either in or out by simply relocating two bolts.



Universal Mount

Mounts to walls, round and square tube and angle iron, with a single mount.

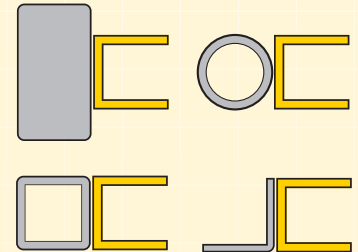

YellowGate RS

- ▼ No Tools required. Quick release pins
- ▼ Highly Mobile with 5" rubber wheels
- ▼ Simple male to female connectors

2" [51mm] Handrails

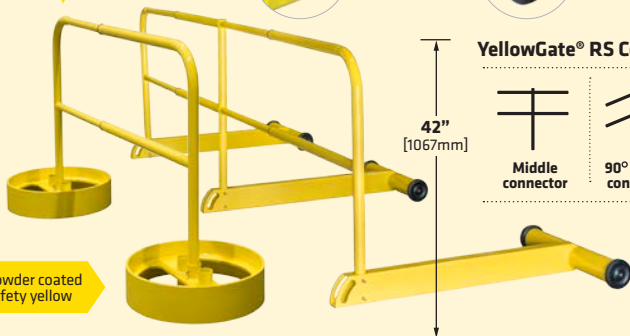

YellowGate® RS Connector Accessories

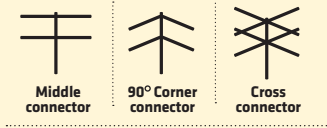

YellowGate XL

The Most Adjustable Barrier Gate Available.

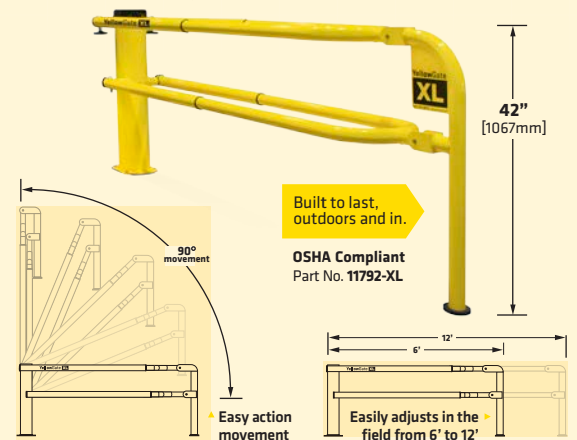



Is your facility safe and FULLY compliant?



New OSHA regulations stipulate heavy fines and even personal liability for unsafe and uncompliant working conditions.

OSHA recently updated it's guidelines with respect to steps and handrails used in all common industrial access and maintenance applications. ErectaStep® is the only fully modular stairs and work platform system that FULLY complies with ALL recent changes to OSHA 1928, sections 23/25/30. No other modular stairs and access system takes your safety and compliance this seriously. Some may say they're OSHA compliant. But look closely, most likely they aren't fully up to date with all components. Call your local ErectaStep® dealer, we'll come out and help you perform a complete safety audit of your work platforms and stair systems to help ensure your facility is as safe is it can be and fully OSHA compliant.

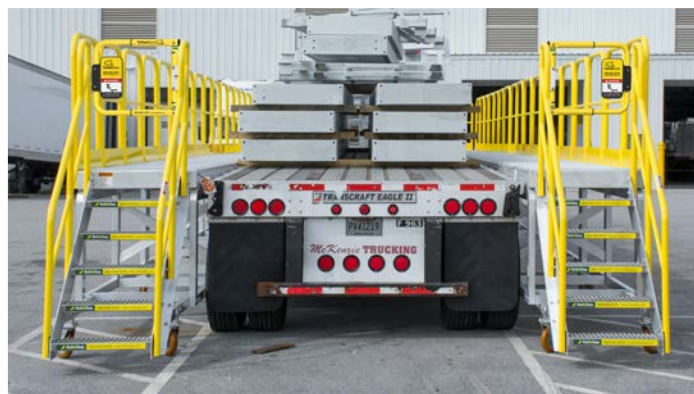



Ships Anywhere in the USA or Canada

ERECTA STEP®

5 Main Components Unlimited Configurations.

Faster and Easier Than Custom Fabrication

Modular Work Platforms and Cross Over Stairs

ErectaStep® quickly configures to gain safe access for maintenance and crossover applications for pipes, dike walls and other obstructions. Three platforms together provide up to 9' of linear clearance, without a tower support required. All pre-engineered and OSHA compliant. No fabrication required.



ErectAStep® Configurator
Visit us online to schedule an appointment for an on-site consultation to fit your specific needs. ▾

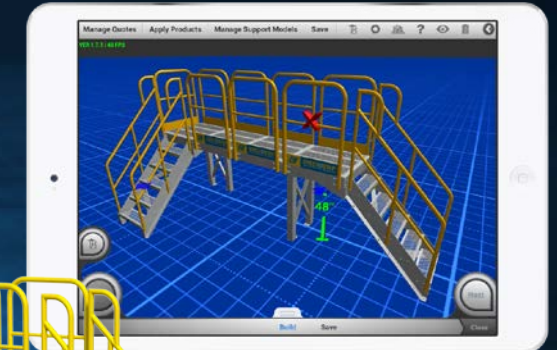

CUSTOM FABRICATION



Instant Design Estimates



Could take up to 2 weeks or more



Instant with iPad Configurator

Pre-Engineered



Needs engineering, adds considerable cost and time



Pre-Engineered, and OSHA compliant

Fast Lead Time



Could take up to 6 weeks



All components are in stock and ready to ship UPS!

Fast and Easy Installation



Could take several days or more



Takes less than a day in most cases

Why buy ErectaStep®?

- ✓ 1. Quick bolt-together assembly for easy installation
- ✓ 2. Real time design and estimation
- ✓ 3. Pre-engineered components
- ✓ 4. Fully engineered and OSHA compliant
- ✓ 5. In stock and ready to ship!



Bolts Together

No welding or fabrication required to construct any configuration.



No Crane Required

PERFECT A STEP®

Customized Industrial stairs and Work Platforms for ANY Application

- Improved productivity
- Reduced risk of injury from slips, trips and falls
- Solves complicated custom access problems

For more information PerfectAStep.com



Safety made simple.

call us toll free **1.888.878.1839**

visit us online ErectAStep.com

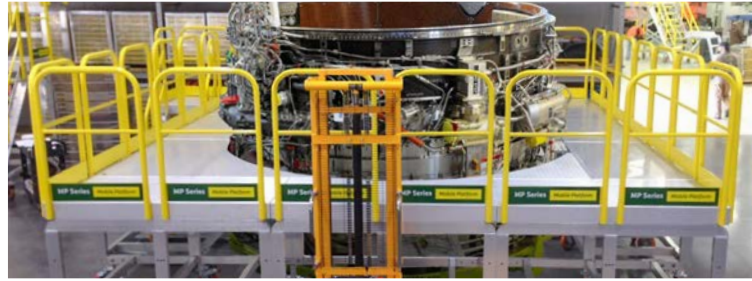
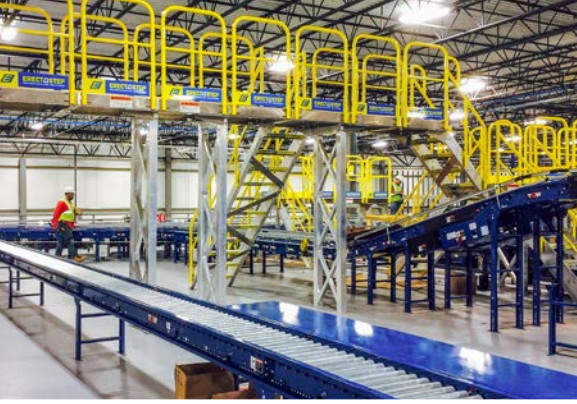

Configure today Install tomorrow.

ErectaStep® Configurator

Visit us online to schedule an appointment for an on-site consultation to fit your specific needs.

