

Product Guide

Hoses · Couplings · Expansion Joints · Nozzles

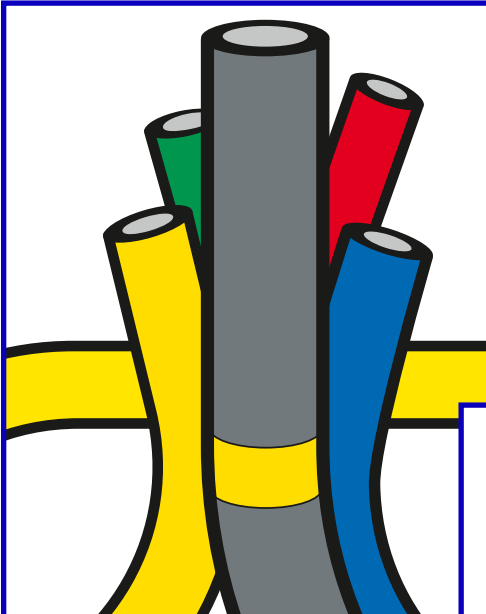

Petrol + Chemical Hoses

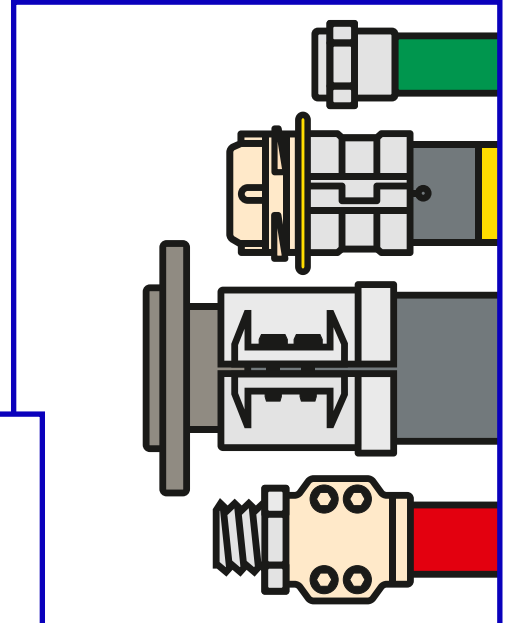

Hose Couplings

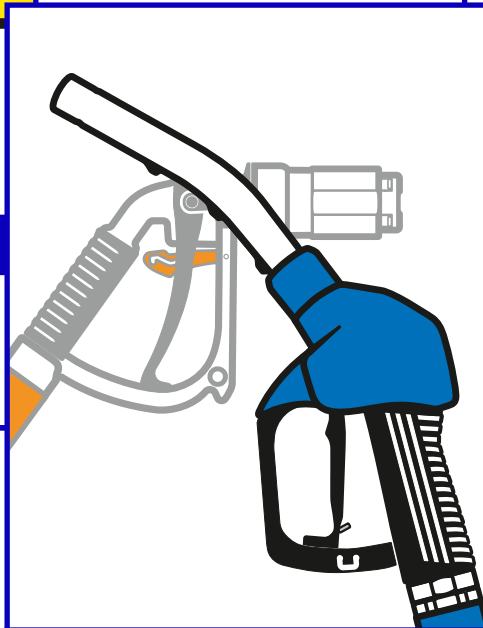

Nozzles + Accessories

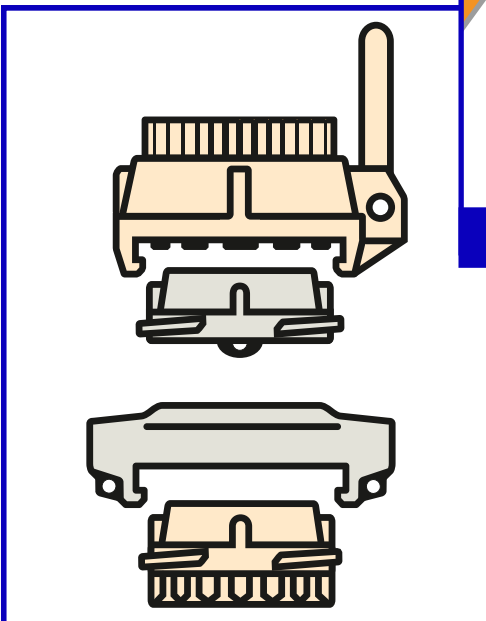

Tank + Pipe Couplings

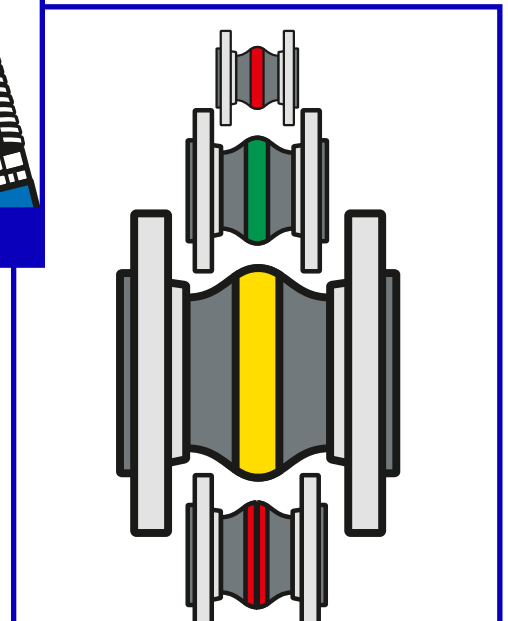

Rubber Expansion Joints

Quality hoses by ELAFLEX / ContiTech, setting the standards. Available as reel, cut lengths or assemblies.

Aircraft Refuelling Hoses (EN ISO 1825, EI 1529)

'YELLOW BAND', types HD-C, VHD, PHD, TW-E Suitable for all aviation fuels. Optional with NEON bands for improved visibility. Specified by all major oil companies. Lining NBR, working pressure 20 bar.



Also available as Low Temperature versions

Fuel Reeling Hoses without Helix (EN 1761)

'YELLOW BAND', type HD 10-200 without helix, for reel operation. Suitable for petroleum based products.

Lining NBR. W.P. 20/25 bar.

Type HD



Tank Truck Hoses (EN 1761)

'YELLOW BAND', type TW 19-200, type STW 125-200 with helix. Suitable for petroleum based products.

Lining NBR. W.P. 16/20 bar.

Type TW



Bunkering Hoses (EN 1765)

Type FHD 75-250, collapsible marine bunkering hose without helix. Suitable as pressure hose for petroleum based products. W.P. 15 bar (10": 10 bar).

Type FHD



DN 100-300 marine cargo hoses with built-in nipples. Category L10 without helix or category S15 with helix.

Types SBL & SBS

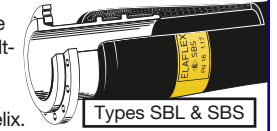

Universal Tank Hoses (EN 12115)

'BLUE-WHITE-BLUE', type UTD 13-38 without helix, type UTS 19-150 with helix. Suitable for most chemicals, petroleum based products and solvents. Lining UPE white with patented OHM conductive stripe. W.P. 16 bar.

Type UTS

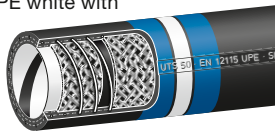

ELAFLOX PLUS FEP (EN 12115)

Type FEP 13-25 D without helix, FEP 19-100 with helix. Universal hose with seamless FEP lining for all standard chemicals. DN 13-50 with light grey cover and OHM-conductive spiral, DN 63-100 with black cover. W.P. 16 bar.

Type FEP

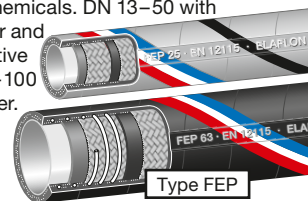

Corrugated Tanker Hoses (EN 12115, EN 1761)

Good flexibility due to corrugations in the cover: Type LTW 50-100 for petroleum products (NBR lining), type UTL 38-100 universal hose (UPE lining). W.P. 10 bar. Also available types LTX & LG, lightweight gravity discharge road tankers hoses. W.P. 4 bar.

Type UTL

Type LTW

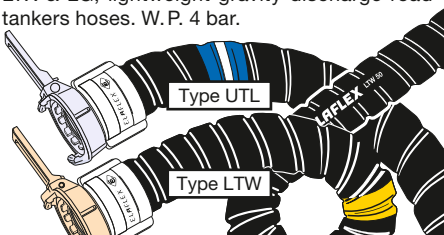

Composite Hoses (EN 13765)

Type FWS (PP or PTFE), flexible general purpose hose for most common chemicals. Temperature range -30°C to 100°C. W.P. 14 bar.

Type FWS

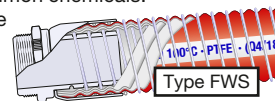

Chemical Hoses (EN 12115)

'LILAC BAND', type CHD 13-50 without helix, CHS 25-150 with helix. Suitable for more than 75% of all industrial chemicals. Lining EPDM. W.P. 16 bar.

Type CHS



FLUORFLEX 2

Ultra-flexible universal hose with helically wound PTFE lining for petrochemical, pharmaceutical and food industry. Temperature range -20°C up to 150°C. W.P. 16 bar.

Type FXD



POLYPAL® CLEAN (EN 12115)

Type PCD 13-38 without helix, PCS 25-100 with helix. 'Clean' universal hose for almost all fluids. Lining UPE bright with conductive spiral stripe. Cover EPDM light grey with OHM-conductive spiral. W.P. 16 bar.

Type PCS

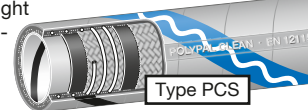

Solvent Hoses (EN 12115)

'BLUE BAND', type LMD 9-25 without helix, LMS 25-150 with helix. For most solvents and paints, also water based. Lining NBR blue, electrically conductive. W.P. 16 bar.

Type LMS



Pharma Hoses (EN 16820, FDA, USP Class VI)

ELAPHARM hose assemblies for highest media purity requirements, with PTFE lining. Type EPH (blue cover, el. isolating) and EPH-OHM (light grey cover, el. conductive) DN 13-50 with crimped connections, also free of dead spaces.

Type EPH



Also available: ElaSil® silicone hose assemblies type ELS 13-102.

Hot Bitumen Hoses (EN 13482)

Type HB 50-100 with helix. Suitable for hot bitumen and heavy fuel, -25°C up to 200°C.

Lining special elastomer. W.P. 7 bar.

Type HB

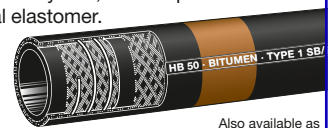

Also available as Tar Spraying Hose HB-ST 19-50

Steam Hose (ISO 6134)

Type SD 13-50. Suitable for wet saturated steam up to max. 18 bar (210°C) and hot water up to 120°C. For cold water up to 25 bar. Lining EPDM.

Type SD



Petrol Pump Hoses (EN 1360)

Quality petrol pump hoses 'SLIMLINE' DN 16-25 for gasoline and diesel fuels, also with biodiesel or ethanol content. Cold flexible down to -30°C (LT-type down to -40°C). Assembly with ferrule type couplings. W.P. 16 bar.

Type SL

Type SL LT

Type SL BIO

many other types

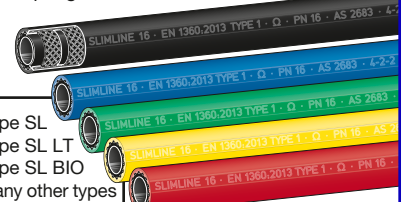

COAX hose assemblies DN 21/8, black or coloured, for active vapour recovery. Cold flexible down to -30°C (LT-type -40°C). W.P. 16 bar.

Type COAX



Safe and secure connections.

Hose Couplings Ferrule Type (EN 14424)

Female/male hose couplings (ferrule type) with union nut, DN 13-25. Brass, also chrome plated, or stainless steel. Also available as non-reusable type NR.

Type M

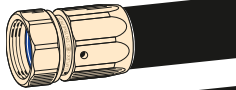

Type V

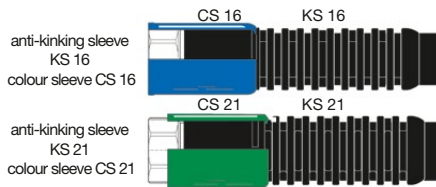
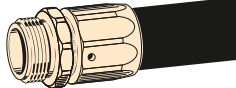

Food + LPG Hose Couplings (DIN 11851, EN 14422)

Hose couplings of stainless steel with special thread for foodstuffs up to 16 bar. Hose couplings brass/steel with ACME thread for LPG up to 25 bar. SPANNFIX or SPANNLOC clamps.

Type RMX

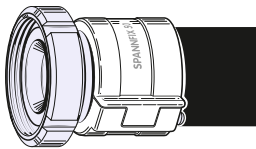

Type ACMC

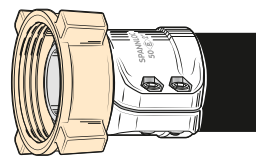

'TW' Hose Couplings (EN 14420-6)

TW hose couplings, one piece or two piece coupler, with SPANNFIX or SPANNLOC clamps. Working pressure up to 16 bar.

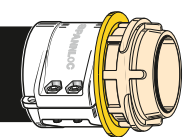

Type VKC

- brass -

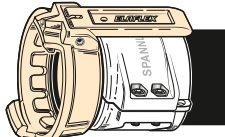

Type MKC

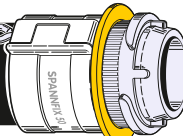

Type VKX...SS

- stainless steel -

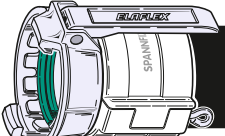

Type MKX...SS

'Storz' Hose Couplings (DIN 14301)

STORZ hose couplings of aluminium. SPANNFIX or SPANNLOC clamps. W.P. up to 10 bar.

Type STKX

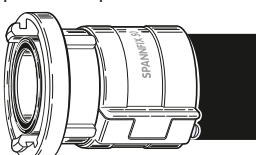

SPANNFIX Hose Couplings (EN 14420-5)

Female/male hose couplings with reusable SPANNFIX pinned safety clamps of hot stamped aluminium. DN 25-100. Working pressure up to 25 bar.

Type MX

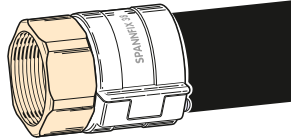

- brass -

Type VX

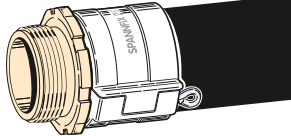

Type MX... SS

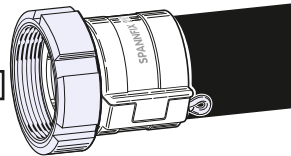

- stainless steel -

Type VX... SS

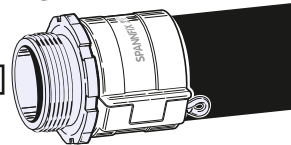

Steel Hose Couplings (EN 14420-5)

Female/male hose couplings of steel, zinc plated and chromated. For LPG, hot water and mechanical engineering applications. Working pressure up to 25 bar. SPANNFIX or SPANNLOC clamps.

Type SMX

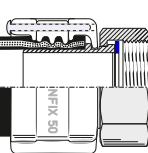

Type SVC

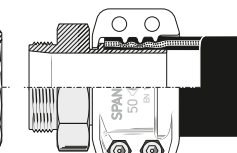

Cam Locking Couplings (EN 14420-7)

Hose fittings of brass, aluminium or stainless steel. With SPANNFIX or SPANNLOC clamps. W.P. up to 16 bar (DN100 10 bar).

Type AVKC

EASYLOC®
female coupler with
automatic lever lock

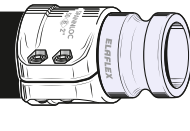

Type AMKX EASY

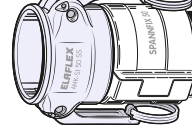

Type AMKX

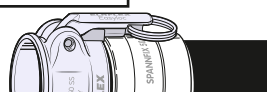

SPANNLOC Hose Couplings (EN 14420-5)

Female/male hose couplings w. reusable SPANNLOC bolted clamps of hot stamped aluminium. DN 13-100. Working pressure up to 25 bar.

Type MC

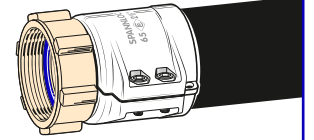

- brass -

Type VC

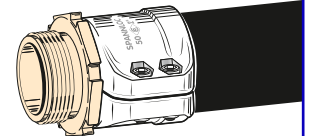

Type MC... SS

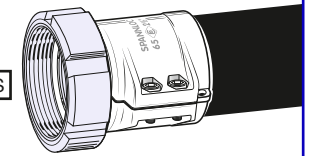

- stainless steel -

Type VC... SS

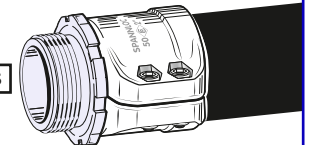

Hose Couplings for Steam (EN 14423)

Male/female hose couplings with bolted clamps of stainless steel or hot stamped brass. Hose tail and union nut either of stainless steel, steel zinc plated + chromated, or brass. Suitable for saturated steam up to +220°C, compressed air, oxygen and oils. W.P. up to 25 bar.

Type SMS...SS



Flanged Hose Couplings (EN 1092-1, EN 14420-4/14423)

Swiveling or fixed flanges, SPANNFIX or SPANNLOC clamps.

- steel, zinc plated
+ chromated -

Type SFX

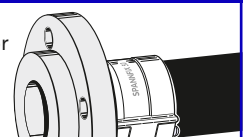

- stainless
steel -

Type SFC-SS



- 'TW' type,
for tank trucks,
aluminium -

Type SFC-TW

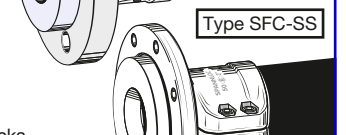

Heavy type for
saturated steam of
steel, zinc plated
and chromated.
Clamps of hot
stamped brass or
stainless steel.

Type SFS

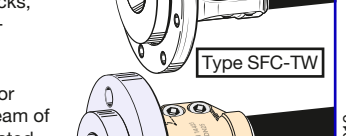

Safe and secure connections.

'TW' Couplings (EN 14420-6, DIN 28450)

Quick couplers to EN 14420-6. One hand tightening without tools, safe and leak-free connection. For tankers and industrial applications. Sizes 2", 3" und 4". Of hot stamped brass, stainless steel or hot stamped aluminium. Dust plugs also of polyamide. Working pressure up to 16 bar.

Type VB
(dust plug - aluminium, polyamide, brass or stainless steel)



Also available:
VB 80 ADR SS
with pressure relief valve

Type MB
(dust cap of aluminium, brass or stainless steel)

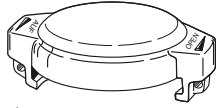

Type MK with bent lever
to provide that the lever can fully close and lock in narrow installations

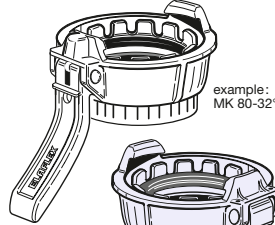

example:
MK 80-32"

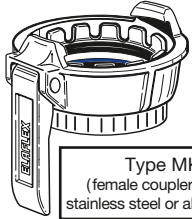

Type MK
(female coupler brass, stainless steel or aluminium)



Type VK
(male coupler brass, stainless steel or aluminium)

Type MK-A SS
with Active Safeguard Lever, prevents accidental opening of the lever

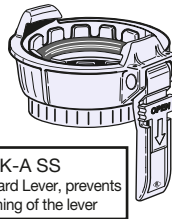

Accessories for Rail Tankers

Rail tanker adapter type KWZ, one end with rail tanker thread 5 1/2", other end male thread BSP or quick coupling. Rail tanker discharge coupling type KWK with male thread or quick coupling.

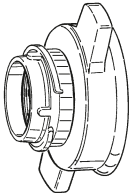

Type KWZ x VK

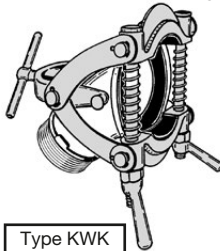

Type KWK

Sight Glasses

Sight glasses type SG (with BSP thread EN ISO 228). Type TSG (one side with tank truck flange). Brass also chrome plated, or aluminium.

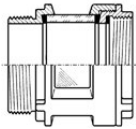

Type SG

Swivels

Swivel hose inlets to avoid torsion of hose assemblies. DN 25-50, of brass or stainless steel. W.P. up to 10 bar.

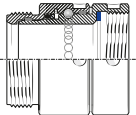

Type DS / DG

Pipe Connectors

Flexible bronze pipe connectors with swiveling oval flanges. Suction service between dispenser + storage tank, max. vacuum 0,9 bar. Type BWO: standard. Type KW: with cathodic protection.

Type BWO



Type KW

Cam Locking Couplings (EN 14420-7)

Female or male couplings, dust caps and dust plugs, DN 13-100, of stainless steel, brass or aluminium. W.P. up to 16 bar. (DN 100 up to 10 bar)



Type AVKI



Type AMKI



Type AMKI EASY

EASYLOC®
female coupler with automatic lever lock

Symmetrical Couplings

Fixed couplings Storz or Guillemin, with BSP thread. All standard sizes of brass, aluminium or stainless steel. Working pressure 10 bar.

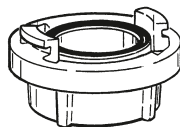

Type Storz IG

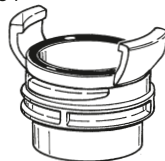

Type Guillemin IG

ELAPAC-FD

Flange sealing material free of plasticisers. Suitable for tank truck and tank installations, for petroleum based products and many other media. Available as cut seals, sheets or coils.

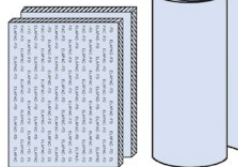
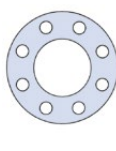

Teflon® PFA Coating

Stainless steel threaded fittings, flanges and couplings are also available with additional Teflon® PFA coating (FDA compliant) on surfaces in contact with medium, for specially aggressive media (e.g. hydrochloric acid, ferro-III-chloride, diluted sulfuric acid). Colour: red.

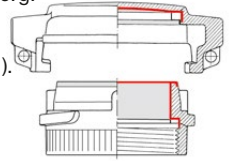

Type...SSE

Dry Disconnect & Break-away Couplings

Self locking couplings, MannTek brand. For liquid media or liquefied gas. Can be coupled up to 7 bar. Brass/bronze, stainless steel or aluminium. W.P. 25 bar (16 bar for aluminium). Also available with selectivity system or flanged type.



Type DDC
Dry
Disconnect
Couplings



Type DGC
Dry Gas
Couplings



Type DAC
Dry Aviation
Couplings

Also available (no picture):

- Break-away Couplings for all liquid media
- Dry Disconnect & Break-aways f. cryogenic media

configure online: manntekconfigurator.elaflex.de

Flanges

Flanges to EN 1092-1 with male thread, short or long design. Of steel, stainless steel, brass or aluminium.

Type FGN
(long design)

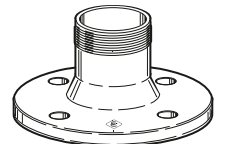

Tank truck welding flanges TFA with pipe stop (also available in space saving square shape TQFA). Type TF without pipe stop. Made of steel or stamped aluminium.

Type TFA



Tank truck flanges TGN, with threaded nipple, to DIN 28462. Of aluminium, brass or stainless steel.

Type TGN

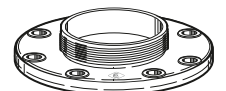

Rubber Expansion Joints

ERV high quality expansion joints DN 25–1000, by ELAFLEX / ContiTech. With swiveling flanges (various types and materials).

ERV-R

RED BAND expansion joint for water, drinking water, waste water, seawater, cooling water, chemical waste water (without oil), chemicals, acids and alkalis, salt solutions, alcohols. Temperature range -40°C up to 100°C, temporarily up to 120°C. Lining Butyl/EPDM.



Type ERV-R

ROTEX

ROTEX expansion joint for permanent service with hot heating water, cooling water and hot air. W. P. 10 bar up to 100°C, 6 bar up to 110°C. Temperature range -40° up to 130°C, temporarily up to 150°C. TÜV approved, DIN 4809. Lining EPDM.



Type ROTEX

ERV-CR

CR expansion joint for cold and warm water, seawater (also oil containing), various waste water, lube oils and greases, air, compressed air. Temperature range -25°C up to 90°C, temporarily up to 100°C. Lining Chloroprene.



Type ERV-CR

ERV-BR

BLUE SPOT expansion joint for abrasive media, sludges, slurries, solid/liquid mixtures and emulsions, dustlike or powdery products. W. P. max. 16 bar. Temperature range -50°C up to 70°C, temporarily up to 90°C. Lining BR/NR.



Type BR

ERP

RED SPOT expansion joint for sanitary installations, cold/warm water, swimming pool water, seawater, drinking water. Highly flexible + low own resistance. W. P. max. 10 bar. Temperature range -40°C up to 90°C, temporarily up to 120°C. Lining Butyl/EPDM.



Type ERP

ERV-G

YELLOW BAND expansion joint for petroleum based products up to 50% aromatics, fuels, aviation fuels, town gas and natural gas. Temperature range -20°C up to 90°C, temporarily up to 100°C. Lining NBR.



Type ERV-G

ERV-GS

YELLOW STEEL expansion joint. Similar to type ERV-G, but fire resistant to ISO 15540 (type approved). Also for cooling water emulsions with oily anticorrosion additives. Temperature range -20°C up to 90°C, temporarily up to 100°C. Lining NBR.



Type ERV-GS

ERV-GS HNBR

YELLOW STEEL HNBR expansion joint for petroleum based products up to 50% aromatics and hydraulic oil. Also for cooling water emulsions with oily anticorrosion additives. Large temperature range -35°C up to 100°C, temporarily up to 120°C. Lining HNBR.



Type ERV-GS HNBR

ERV-G LT

YELLOW BAND LT expansion joint designed for low temperature applications for standard-conform petroleum based products. Temperature range -40°C up to 90°C, temporarily up to 100°C. Lining NBR.



Type ERV-G LT

ERV-OR

ORANGE BAND expansion joint for Liquid Petroleum Gas (LPG) according to EN 589. Temperature range -20°C up to 90°C, temporarily up to 100°C. Lining NBR.



Type ERV-OR

ERV-GR

GREEN BAND expansion joint for chemicals, acids, alkalis and aggressive chemical waste water. Temperature range -20°C up to 100°C, temporarily up to 110°C. For oil-contaminated compressor air up to 90°C. Lining CSM.



Type ERV-GR

ERV-W

WHITE BAND expansion joint for foodstuffs, also containing oil and fat. Liner conforms to rec. XXI of BfR and FDA-21CFR 177.2600. Temperature range -20°C up to 90°C, temporarily up to 100°C. Lining NBR, light grey.



Type ERV-W

Accessories



With additional PTFE liner (ERV...TA)



With tie rods as limiters (ERV...ZS)



With inner protection sleeve of stainless steel, e.g. for granulates (ERV...SR)



With vacuum support spiral (ERV...VSD) or ring (ERV...VSR)



Flame protection cover (FSH)

Nozzles by ELAFLEX / Hiby: ergonomic design, long life, fully serviceable.

ZVA Slimline 2 (EN 13012, ATEX, TÜV)

Automatic nozzle for flowrate up to 80 l/min. Suitable for gasoline, also with ethanol content, diesel, fuel oil and biodiesel. Working pressure 0,5 up to 3,5 bar.

Type ZVA Slimline 2

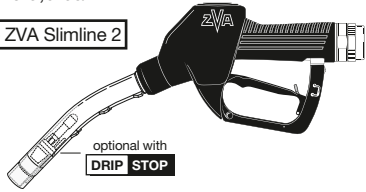

Also available as Low Temperature version

ZVA 25 (EN 13012, ATEX)

Automatic nozzle for flowrate up to 140 l/min, DN 25. Suitable for gasoline, diesel and fuel oil. Working pressure 0,5 up to 3,5 bar.

Type ZVA 25

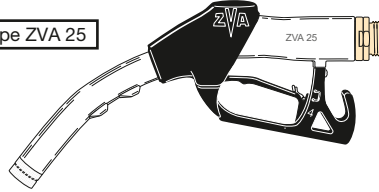

Also available as aircraft refuelling version

ZVA 32 (ATEX)

Automatic nozzle for flowrate up to 200 l/min, DN 32. Suitable for diesel, light fuel oil, petroleum, Avgas and Jet-A1. Working pressure 1,5 up to 6 bar.

Type ZVA 32

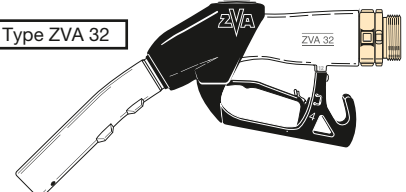

Also available as aircraft refuelling version

ZVA Slimline 2 GR (EN 13012, ATEX, TÜV)

Automatic nozzle for active vapour recovery. Suitable for all standard gasoline fuels (also with ethanol content), up to 45 l/min. Design 'GRV' with integrated vapour valve 'On/Off', Design 'GRVP' with vapour proportional valve. Working pressure 0,5 to 3,5 bar.

Type ZVA Slimline 2 GR

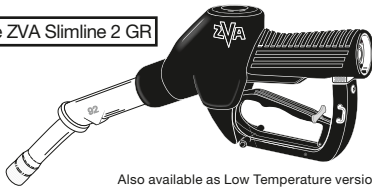

Also available as Low Temperature version

Corrosion Resistant Automatic Nozzles

Automatic nozzles in special construction of gunmetal (ZVA-RG) or bronze (ZVA-GBZ). Suitable for solvents, alcohols and chemicals.

Type ZVA - RG

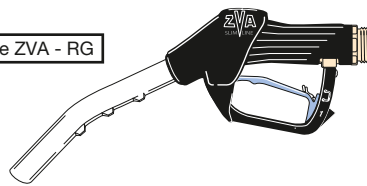

ZV 19 / ZV 25

Manually operated nozzles for gasoline, diesel, fuel oil and vegetable oil. ZV 19 (DN 19) up to 100 l/min; ZV 25 (DN 25) up to 140 l/min. W.P. up to 3,5 bar. Special types for chemicals available.

Type ZV 19

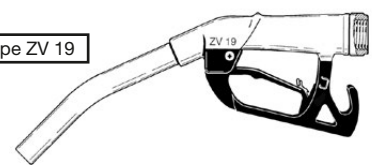

LPG Nozzle, Accessories

Autogas (LPG) nozzle with ACME, DISH or EURO coupling. For propane, butane and mixtures up to 50 l/min. W.P. up to 25 bar.

Type ZVG 2
ACME

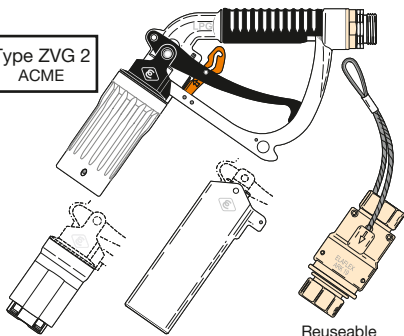

- DISH - - EURO -

Reusable
Safety Break
ARK 19

ZVA for AdBlue® (DEF, ARLA 32, AUS 32)

Automatic nozzle for urea solution (AdBlue®, DEF). Flowrate up to 40 l/min. Working pressure 0,5 to 3,5 bar. Spout with magnet opening; refuelling only possible with ELAFIX 40 magnet adapter within vehicle filler neck.

Type ZVA AdBlue HV

Also available as ZVA AdBlue LV for light vehicles

ELAFIX 40

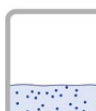

SSB 16 SS
Safety Swivel Break

Safety Breaks (EN 13617-2, ATEX)

Self-closing safety break couplings for nozzles, reusable. To protect dispensers, hose assemblies and cars in case of drive-off incidents.

SSB 16
f. ZVA SL 2,
ZVA Slimline



PSB
Pump
Safety Break

CSB 21
f. ZVA SL 2 GR,
ZVA 200 GR

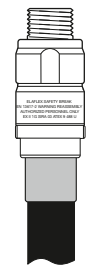
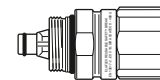

SSB 25
f. ZVA 25

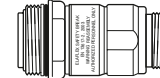

SSB 32
f. ZVA 32

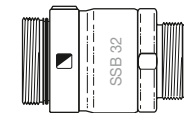

Bulk Delivery Nozzles

Manually operated fuel oil nozzles DN 32-50, types ZV 400, ZV 500 and ZH 50. Available either with fixed spout or TW coupling. Flowrates 250-650 l/min, W.P. up to 10 bar.

Type ZV 400
with spout DN 38

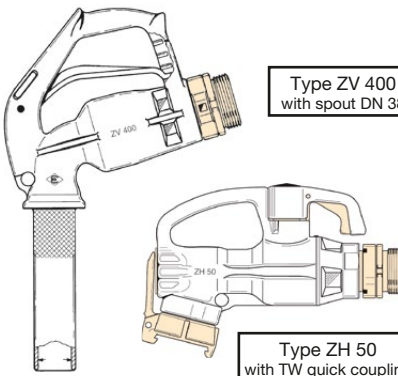

Type ZH 50
with TW quick coupling

Nozzles for Aircraft Refuelling

Automatic or manually operated nozzles for overwing refuelling. Suitable for AVGAS and JET fuels. Flowrates: ZVF 25 and ZVA 25 up to 140 l/min, ZVA 32 up to 200 l/min, ZVF 50 up to 400 l/min.

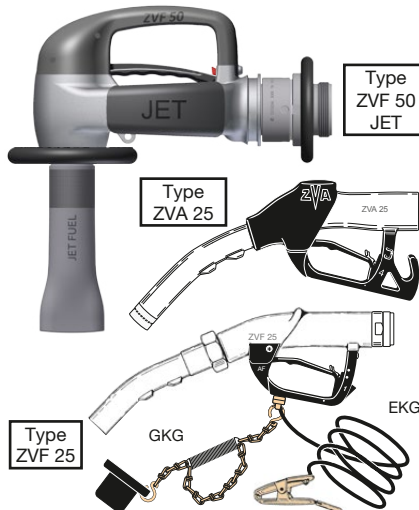

Type
ZVF 50
JET

Type
ZVA 25

Type
ZVF 25

GKG

EKG

This brochure shows only a small part of the Elaflex product range. Further information from our distribution partners or from:

ELAFLEX HIBY GmbH & Co. KG

Schnackenburgallee 121
22525 Hamburg / Germany
Tel.: +49 40 540 00 5-0
Fax: +49 40 540 00 5-67
E-Mail: info@elaflex.de
Internet: www.elaflex.de/en